



rtc[®]

COUPLING TECHNOLOGY



097

rtc TYPE



Temperature Range - Temperaturbereich
 FPM (V) -20°C + 180°C (- 4°F + 356°F)

Working Pressure - Betriebsdruck
 rtc 097.08 20 bar (290 PSI)

Working Pressure - Betriebsdruck
Stainless Steel - Edelstahl
 rtc 097.08 100 bar (1450 PSI)

Flow size - Nennweite
 rtc 097.08 8 mm

Material of Standard Coupler
Material für die Standardversion

Socket body - Kupplungsgrundkörper	Brass - Messing
Valve - Ventil	Brass - Messing
Springs - Federn	Stainless Steel - Edelstahl

Plug body - Nippelsgrundkörper	Brass Nickel plated - Messing vernickelt
Plug back part Nippel hinterteil	Brass Messing

Using Area

- Robotic tool changer
- On temperature regulation applications of mold and tool changer with hot or cold water, oil etc
- Injection moulding industries
- On steam line

Anwendungsbereiche

- Roboterwerkzeugwechsler
- Werkzeugtemperierung
- Kühlung mit Öl oder Wasser
- Kunststoffindustrie
- Dampfanwendungen

Material of Stainless Steel Coupler

Material für die Edelstahlversion

Socket body - Kupplungsgrundkörper	Stainless Steel - Edelstahl
Sleeve - Hülse	Stainless Steel - Stahl vernickelt
Springs - Federn	Stainless Steel - Edelstahl
Locking Ring - Sprengring	Stainless Steel - Edelstahl
Balls - Kugeln	Stainless Steel - Edelstahl

Plug - Nippel	Stainless Steel - Edelstahl
---------------	-----------------------------

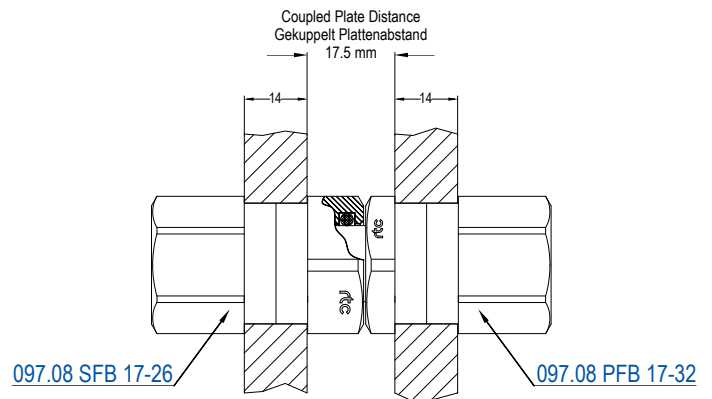
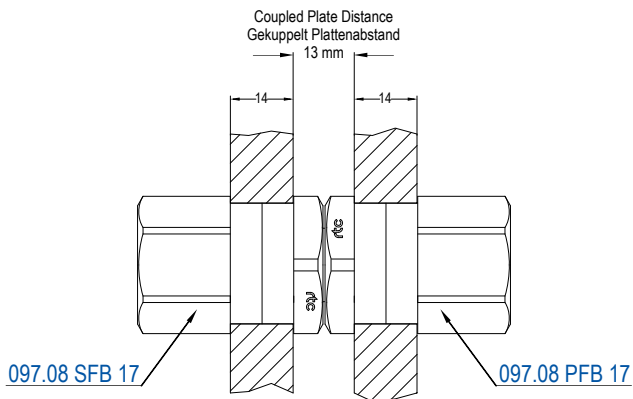

Flow Rate vs Pressure Drop Graph / Durchflussrate vs Druckabfall

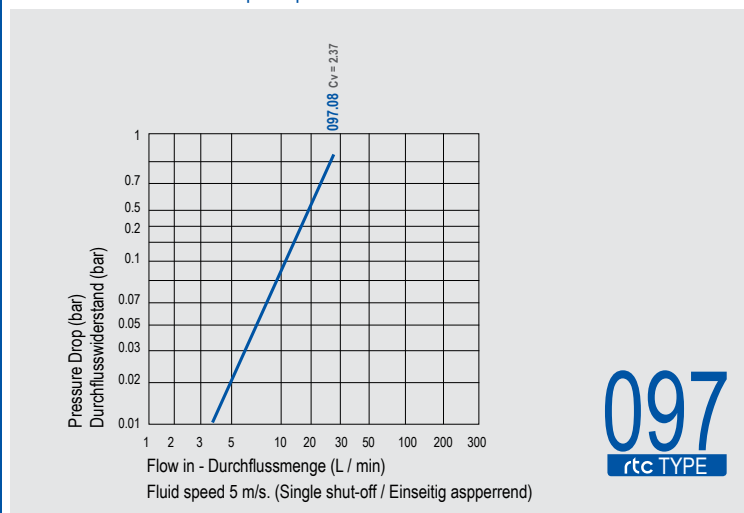

rtc TYPE 097

Male thread socket with valve / Verschlusskupplung mit Aussengewinde



Socket / Kupplung

Size / Größe	Order No / Bestellnr.	Ød	Ød1	Ød2	L	L1	SQR.
08	097.08 SMB 2415	M24x1.5	27	29.5	22	6.5	27

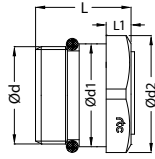

rtc TYPE 097

Female thread socket with valve / Verschlusskupplung mit Innengewinde

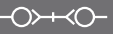

Socket / Kupplung

Size / Größe	Order No / Bestellnr.	Ød	Ød1	Ød2	L	L1	SQR.
08	097.08 SFB 17	BSP 3/8	27	29.5	40.5	6.5	27

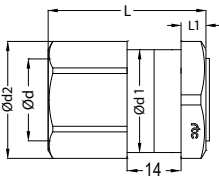

rtc TYPE 097

90° Female thread socket with valve / Verschlusskupplung mit Innengewinde



Socket / Kupplung

Size / Größe	Order No / Bestellnr.	Ød	Ød1	Ød2	L	L1	SQR.
08	097.08 SFB 17-90	BSP 3/8	27	29.5	63	6.5	27

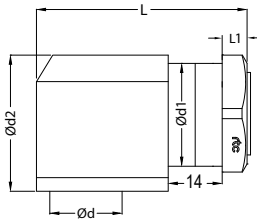

rtc TYPE 097

Male thread plug with valve / Verschlussnippel mit Aussengewinde



Plugs / Nippel

Size / Größe	Order No / Bestellnr.	Ød	Ød1	Ød2	L	L1	SQR.
08	097.08 PMB 2415	M24x1.5	27	29.5	22	6.5	27

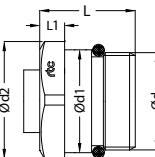

rtc TYPE 097

Female thread plug with valve / Verschlussnippel mit Innengewinde



Plugs / Nippel

Size / Größe	Order No / Bestellnr.	Ød	Ød1	Ød2	L	L1	SQR.
08	097.08 PFB 17	BSP 3/8	27	29.5	46	6.5	27

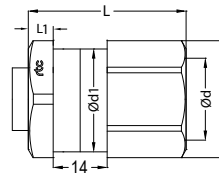

rtc TYPE 097

90° Female thread plug with valve / Verschlussnippel mit Innengewinde



Socket / Kupplung

Size / Größe	Order No / Bestellnr.	Ød	Ød1	Ød2	L	L1	SQR.
08	097.08 PFB 17-90	BSP 3/8	27	29.5	63	6.3	27

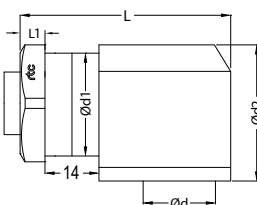



Male thread socket with valve / Verschlusskupplung mit Aussengewinde

TYPE 097 **rtc**

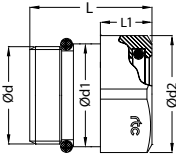
Socket / Kupplung	Size / Größe	Order No / Bestellnr.	Ød	Ød1	Ød2	L	L1	SQR.
	08	097.08 SMB 2415x26	M24x1.5	27	29.5	26.5	11	27



Female thread socket with valve / Verschlusskupplung mit Innengewinde

TYPE 097 **rtc**

Socket / Kupplung	Size / Größe	Order No / Bestellnr.	Ød	Ød1	Ød2	L	L1	SQR.
	08	097.08 SFB 17x26	BSP 3/8	27	29.5	45	11	27



Female thread socket with valve / Verschlusskupplung mit Innengewinde

TYPE 097 **rtc**

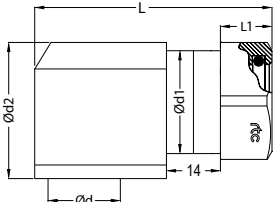
Socket / Kupplung	Size / Größe	Order No / Bestellnr.	Ød	Ød1	Ød2	L	L1	SQR.
	08	097.08 SFB 17x26-90	BSP 3/8	27	29.5	67.5	11	27



Plug with male thread / Nippel mit Aussengewinde

TYPE 097 **rtc**

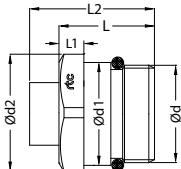
Plugs / Nippel	Size / Größe	Order No / Bestellnr.	Ød	Ød1	Ød2	L	L1	L2	SQR.
	08	097.08 PMB 2415x32	M24x1.5	27	29.5	22	6.5	32	27



Female thread plug with valve / Verschlussnippel mit Innengewinde

TYPE 097 **rtc**

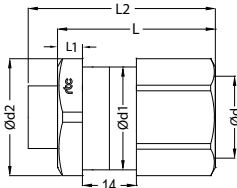
Plugs / Nippel	Size / Größe	Order No / Bestellnr.	Ød	Ød1	Ød2	L	L1	L2	SQR.
	08	097.08 PFB 17x32	BSP 3/8	27	29.5	46	6.5	50.5	27



Female thread plug with valve / Verschlussnippel mit Innengewinde

TYPE 097 **rtc**

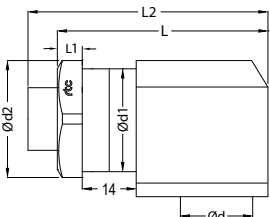
Socket / Kupplung	Size / Größe	Order No / Bestellnr.	Ød	Ød1	Ød2	L	L1	L2	SQR.
	08	097.08 PFB 17x32-90	BSP 3/8	27	29.5	63	6.5	73	27